

WORK[®] PRO 



NEO SET 100 BT

User Manual / Manual de Uso

Rev 15.12.01

1. Introduction

The new **NEO SET 100 BT** is a stylish and elegant audio system that will create the perfect background atmospheres. This set is composed of two full range **NEO 3 S** installation loudspeakers and one **NEO S8 A 2.1 BT** acting as amplified subwoofer.

The **NEO SET 100 BT** concept and design make possible to integrate this system in every project. It includes independent volume controls and the possibility to set the crossover frequency, which gives the contractors a greater control of the whole installation, adapting the system to the specific type of audio source.

This set is available in black and white finish.

2. Features

NEO 3 S

- Full range loudspeaker designed for fixed installations
- 50W R.M.S. @ 8Ω
- Built-in overloading protection
- Aluminium grille for a long lifetime
- Plastic wall-mount bracket with fast mounting system (included)
- Mounting bracket enables pan and tilt
- Euroblock screw terminal for easier installation.

NEO S8 A 2.1 BT

- Self-powered Subwoofer.
- Unbalanced LINE level input.
- 8" woofer with double coil.
- Amplifier power: 40W (Subwoofer) + (20W+20W satellites).
- Bluetooth function
- Master and subwoofer separated volume controls.
- Crossover frequency adjustment (50 Hz-150 Hz).
- Selectable main supply AC 115V/230V.
- Made of MDF wood.
- Fixation handle (vertical/horizontal).

NEO SET 100 BT

3. Rear View

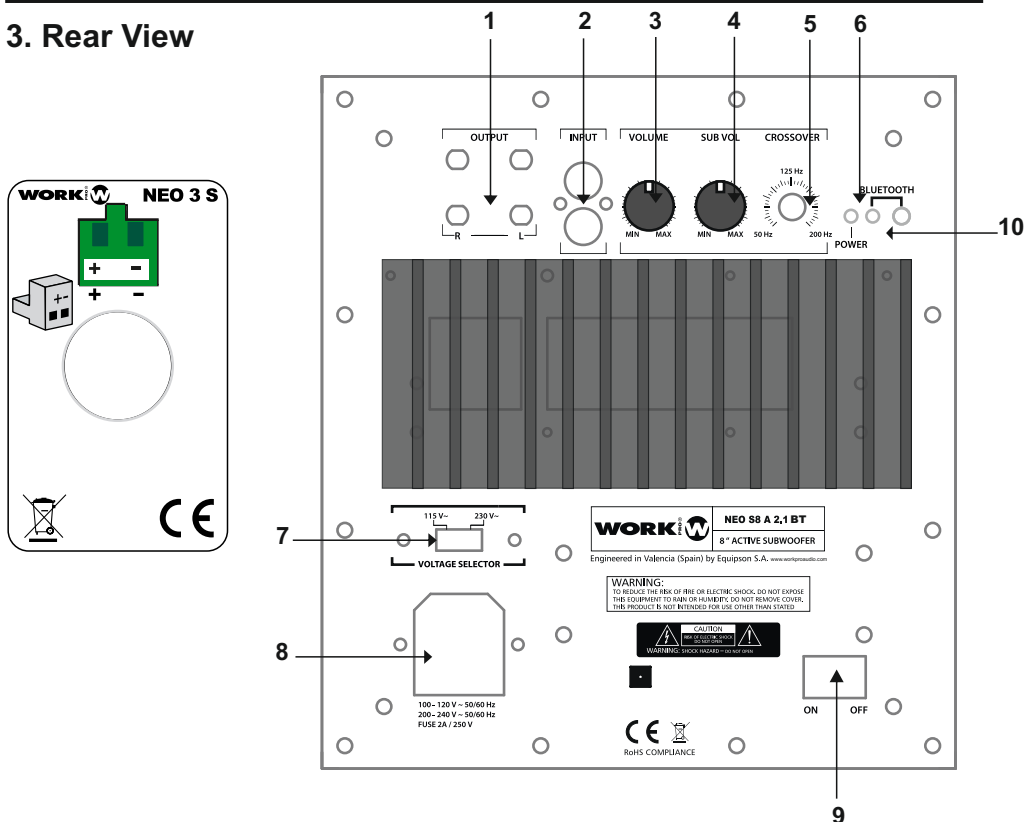

1. **L/R OUTPUT:** Connect the NEO 3 S here, one loudspeaker on each channel
2. **UNBALANCED LINE INPUT:** These RCA connectors accept an unbalanced line full range signal from pre-amplifier output, mixer, etc.
3. **VOLUME CONTROL:** This rotary control adjust the master level.
4. **SUBWOOFER CONTROL:** This rotary control adjust the subwoofer level.
5. **SUBWOOFER CROSFADER:** This rotary control adjust a variable low pass filter to set the upper frequency (from 50 Hz to 150 Hz).
6. **POWER LED:** This LED lits when the unit is connected to main supply
7. **MAIN VOLTAGE SELECTOR:** It is possible to select the mains input supply (115/230V AC)
8. **MAIN SUPPLY:** AC 100-120 /220-240V, 50/60 Hz. Connect the included Schuko-IEC cable.
9. **POWER SWITCH:** This two position switch controls the power status of the device

10. BT FUNCTION (Switch & LED status): Press BT switch for 3s, then hearing a beep and the green LED light flashing, indicating that the Bluetooth is turned on and can be matched with other device. When it is matched, there will be a prompt tone. You can play music through the unit and all controls are controlled by the paired device (such as mobile phones).

Turn off: When the Bluetooth function is on, press the switch 3s, hearing a beep and the green LED will be off.

4. Specifications

Model:	NEO 3 S
Elements:	2.5" Woofer
Low impedance load:	50W RMS (8 ohm) (with overload protection)
Frequency response:	150 Hz - 20 kHz
Sensitivity:	87 dB (1W/1m)
Max. SPL:	100 dB (1m)
Material (enclosure):	ABS plastic
Material (grille):	Aluminium
IP rating:	IP 45
Connection type:	2 pin Terminal Euroblock
Finished colour:	RAL 9003 (W) / RAL 9004 (B)
Dimensions:	95 x 85 x 100 mm
Weight:	0,5 kg (each)

MODEL		NEO S8 A 2.1 BT	
		Type	Self-powered subwoofer
Elements	Woofers		8" woofer
Type			Double coil
Impedance	LINE		22 kΩ
Max. input level		Input	0.775V rms
AMPLIFIER			
Output power	40 W rms (Subwoofer) + (20W+20W satellites)		
Frequency Response	35 Hz - 20 kHz		
Crossover frequency	50 Hz - 200 Hz (selectable)		
Main supply	AC 115V /230V (selectable)		
Connectors	RCA connectors (unbalanced L - R inputs)		
Fixation system	Fixation handle horizontal/vertical (interchangeable)		
Material	MDF wood		
Colors	Black and White		
Dimensions	520 x 400 x 130 mm		
Weight	9,6 kg		

* Specifications are subject changes without notices.

5. Dimensions

in mm.

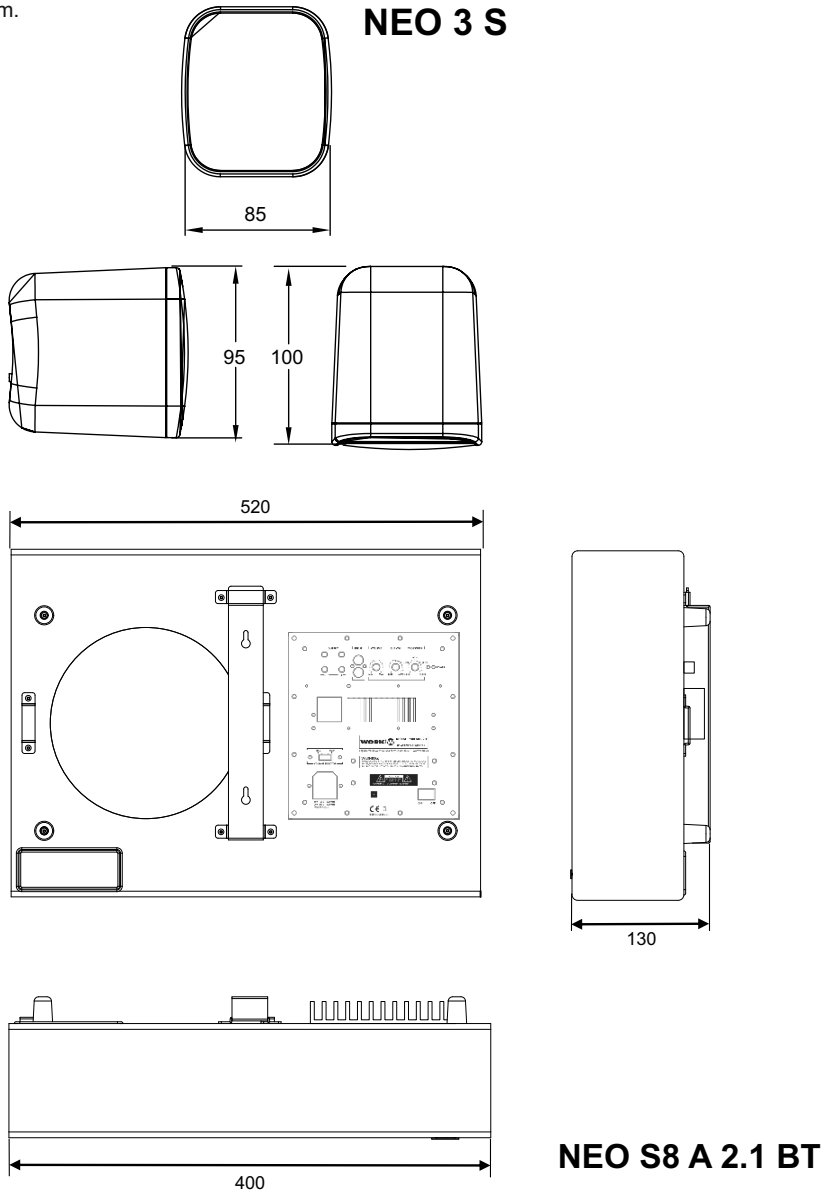

Plastic Wall-mount bracket (NEO 3 S)

1	Rear wall mounting part
2	Threaded Ball
3	Locking nut
4	Fixation screw (x2)
5	Fixation nut

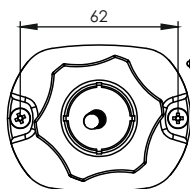
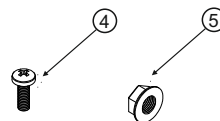
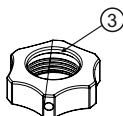
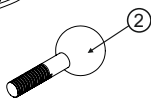
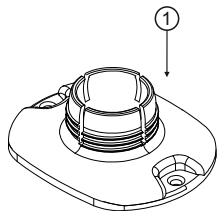

figure 1

Use the wall mounting part (1) to mark the fixing points on the wall. Take into account the dimensions between holes and the diameters marked in figure 1. Drill wall and insert wall fixings. Screw wall mounting part to wall. Ensure that suitable screws and wall fixings are used. If in any doubt contact a suitably qualified expert.

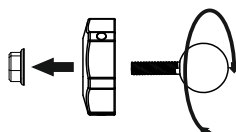

figure 2

Pass the threaded ball piece (2) through the locking nut (3) and screw it directly into the loudspeaker. Tighten M6 nut (5) against the loudspeaker with a spanner. Do not over tighten.

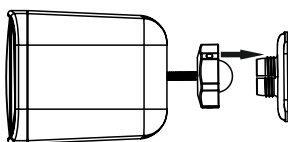

figure 3

Attach the complete set (loudspeaker + threaded ball + locking nut) to the wall mounting part (1). See figure 3.

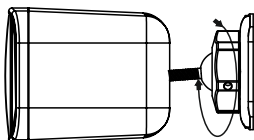

figure 4

Screw the locking nut (3) but not fully tight yet. See figure 4. Angle the loudspeaker to obtain the desired orientation. Once the angle is final, fully tighten the locking nut, but do not over tighten.

1. Introducción

NEO SET 100 BT es un nuevo y elegante sistema de audio que permite crear la atmósfera perfecta. Este set está compuesto por 2 altavoces todo rango **NEO 3 S** y uno **NEO S8 A 2.1 BT** actuando como subwoofer autoamplificado.

El concepto y diseño de **NEO SET 100 BT** hace posible integrar este sistema en cualquier proyecto. Incluye control independientes de volumen y la posibilidad de configurar la frecuencia del crossover, permitiendo a los instaladores un gran control de la instalación, adaptando el sistema a los requerimientos específicos de la fuente de audio.

Este set está disponible en blanco y negro.

2. Características

NEO 3 S

- Altavoz full range diseñado para instalaciones fijas.
- 50W R.M.S. @ 8Ω.
- Incorpora protección ante sobrecargas.
- Rejilla de aluminio
- Soplete de pared fabricado en plástico con sistema de montaje rápido (incluido)
- Este soporte permite mover la unidad en ambos ejes
- Terminal Euroblock para una fácil instalación

NEO S8 A 2.1 BT

- Subwoofer autoamplificado.
- Entrada de nivel LINE desbalanceada.
- Woofer de 8" con doble bobina.
- Función Bluetooth
- Potencia del amplificador: 40W (Subwoofer) + (20W+20W satélites).
- Controles de volumen Master y subwoofer separados.
- Frecuencia de crossover ajustable (50 Hz-150 Hz).
- alimentación seleccionable AC 115V/230V.
- Fabricado en madera MDF.
- Asa de fijación (vertical/horizontal).

3. Vista Trasera

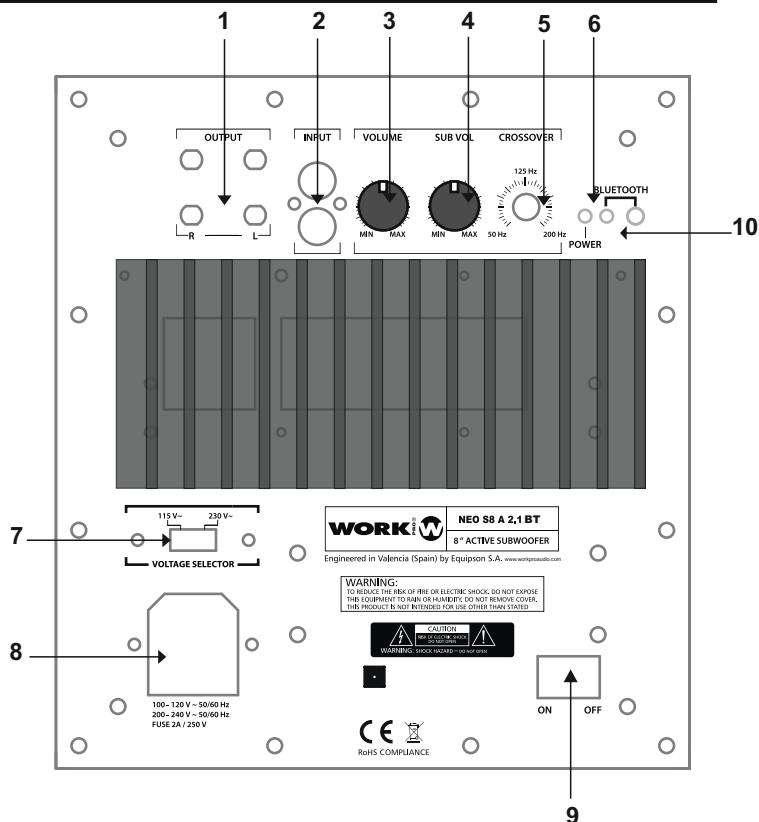
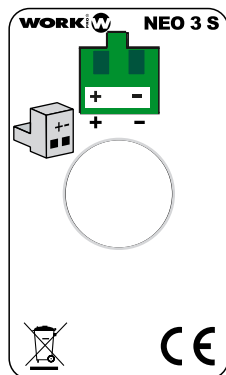

1. **SALIDA L/R** : Conecte los NEO 3 S aquí, un altavoz en cada canal
2. **ENTRADA LINE DESBALANCEADA**: Estos conectores RCA aceptan señal desbalanceada full range procedente de la salida de un amplificador, mezclador, etc
3. **CONTROL VOLUME**: Este mando rotativo ajusta el volumen general (Master)
4. **CONTROL SUBWOOFER**: Este mando rotativo ajusta el volumen del subwoofer
5. **CROSSFADER SUBWOOFER**: Este mando rotativo ajusta un filtro paso bajo configurable entre 50 Hz y 150 Hz.
6. **LED POWER**: Este LED se ilumina cuando la unidad se conecta a la red eléctrica.
7. **MAIN VOLTAGE SELECTOR**: Es posible seleccionar el voltaje de entrada(115/230V AC)
8. **MAIN SUPPLY**: AC 100-120 /220-240V, 50/60 Hz. Conecte el cable Schuko-IEC incluido
9. **INTERRUPTOR DE ENCENDIDO**: Este interruptor de 2 posiciones controla el encendido/apagado de la unidad.

NEO SET 100 BT

10. FUNCION BT (Conmutador y LED de estado): Presione el interruptor 3s, oirá un pitido y el LED verde parpadeará, indicando que el Bluetooth está encendido y puede ser conectado a otro dispositivo. Cuando se enlacen ambos aparatos, oirá un tono. Puede escuchar audio en este dispositivo, todos los controles se realizan desde el dispositivo pareado (como un dispositivo móvil).

Apagado: Con la función Bluetooth activa, presione el conmutador durante 3s, escuchará un pitido y el LED verde se apagará.

4. Especificaciones

Modelo:	NEO 3 S
Elementos:	2.5" Woofer
Potencia soportada:	50W RMS (8ohm) (con protección de sobrecarga)
Respuesta en frecuencia:	150 Hz - 20 kHz
Sensibilidad:	87 dB (1W/1m)
Max. SPL:	100 dB (1m)
Material (recinto):	Plástico ABS
Material (rejilla):	Aluminio
Rango IP:	IP 45
Tipo de conexión:	Terminal Euroblock (2 pines)
Acabado:	RAL 9003 (W) / RAL 9004 (B)
Dimensiones:	95 x 85 x 100 mm
Peso:	0,5 kg (each)

MODELO		NEO S8 A 2.1 BT
	Tipo	Subwoofer autoamplificado
Elementos	Woofer	8" woofer
Tipo		Doble bobina
Impedancia	Entrada LINE	22 kΩ
Max. nivel entrada		0.775V rms
AMPLIFICADOR		
Potencia de salida	40 W rms (Subwoofer) + (20W+20W satelites)	
Respuesta en frecuencia	35 Hz - 20 kHz	
Frecuencia del Crossover	50 Hz - 200 Hz (seleccionable)	
Alimentación	AC 115V /230V (seleccionable)	
Conectores	Conectores RCA	
Sistema de fijación	Asa de fijación horizontal/vertical (intercambiable)	
Material	Madera MDF	
Colores	Blanco y Negro	
Dimensiones	520 x 400 x 130 mm	
Peso	9,6 kg	

* Especificaciones sujetas a cambio sin previo aviso

5. Dimensiones

En mm.

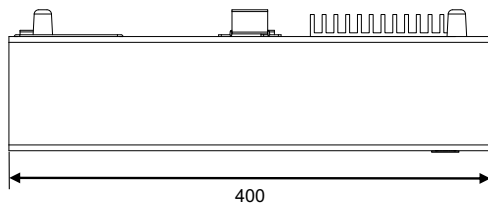
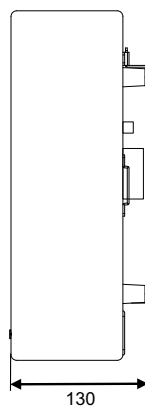
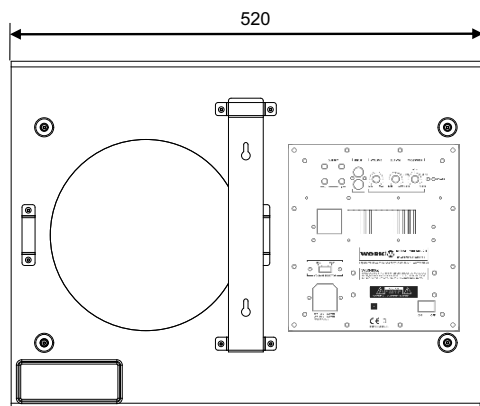
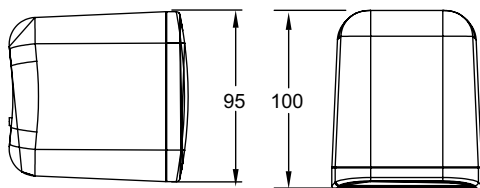
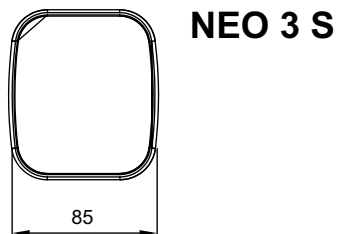

NEO S8 A 2.1 BT

Soporte plástico de fijación a pared (NEO 3 S)

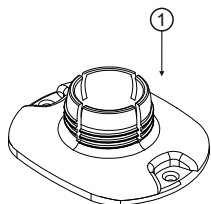

1	Pieza de montaje a pared
2	Bola roscada
3	Tuerca de fijación
4	Tornillo de fijación (x2)
5	Tuerca de fijación



figura 1

Use la pieza de montaje (1) para marcar los puntos de fijación a la pared. Tenga en cuenta las medidas y diámetros marcados en la figura 1.
Fije la pieza a la pared. Asegúrese de fijarlo con todos los tornillos. Si tiene cualquier duda, consulte con un técnico.

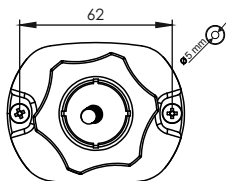
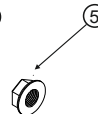
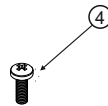
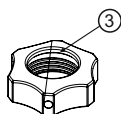
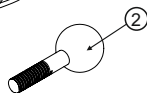

figura 2

Pase la pieza roscada (2) a través de la tuerca de bloqueo (3) y atornille directamente al altavoz.
Apriete la tuerca M6 (6) al altavoz.
No la apriete completamente.

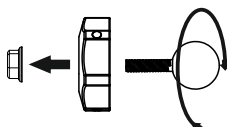

figura 3

Junte todo el set (altavoz+bola roscada+tuerca de bloqueo) a la pieza montada en la pared (1).
Ver figura 3

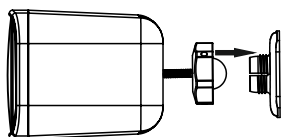

figura 4

Atornille la tuerca de bloqueo (3) pero no del todo.
Ver figura 4. Angule el altavoz para obtener la orientación deseada. Una vez hecho esto, apriete la tuerca completamente.

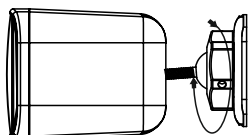

This symbol on the product or on its packaging indicates that this product shall not be treated as household waste. Instead it shall be handed over to the applicable collection point for the recycling of electrical and electronic equipment. By ensuring this product is disposed of correctly, you will help prevent potential negative consequences for the environment and human health, which could otherwise be caused by inappropriate waste handling of this product. The recycling of materials will help to conserve natural resources. For more detailed information about recycling of this product, please contact your local city office, your household waste disposal service or the shop where you purchased the product.

Manufactured by **EQUIPSON, S.A.**
<http://www.workproaudio.com>