



# NEO 5A ES

User Manual / Manual de Uso

Rev 17.08.01

A NEO 5A ES carton contains an active loudspeaker and a passive one (black or white), two metallic wall-mount brackets, and a 3m link cable.

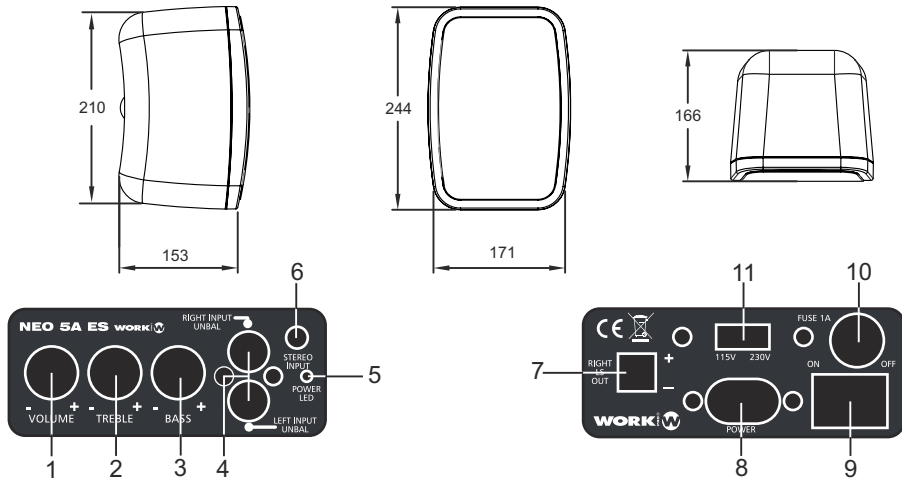

1	Volume Control
2	Treble Control
3	Bass Control
4	L/R Unbalanced Input (RCA connectors)
5	LED power
6	Stereo input (Mini-jack 3.5 mm) (*)

7	Link connection 2-pin euroblock (Passive unit)
8	Mains supply input (Use the included cable)
9	Power Switch ON/OFF
10	Fuse Holder
11	AC 115V/230V main power selector

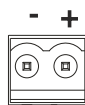

(\*) **This connector overrides RCA input**

The connection is made through euroblock terminals.

Take it into account the correct polarity.

Use the included twin conductors cable (Red/Black) 3m long to connect both loudspeakers.

Elements.....	5" Woofer + 0,5" Tweeter
Power Output .....	2 x 25 W RMS
Input Sensitivity.....	1V /2.21 dBu
Frequency Response .....	60Hz - 20kHz
Dimensions .....	171 x 244 x 166 mm
Material (enclosure) .....	ABS plastic
IP rating .....	IP 54
RAL colour code .....	RAL 9003 (W) / RAL 9004 (B)
Material (grille) .....	Aluminium
Weight .....	2,7 Kg

Specifications are subject to change without notice

## NEO 5A ES, Low consumption in off mode (Explanation)

The **NEO 5 A ES** features a low power consumption in off mode. Therefore, in absence of input signal, the consumption falls down 1W.

This system has been designed taking into account that its activation/desactivation is not appreciated by the audience.

This features complies Ecodesign standard **EN 62301:2005+1275/2008/EC**.

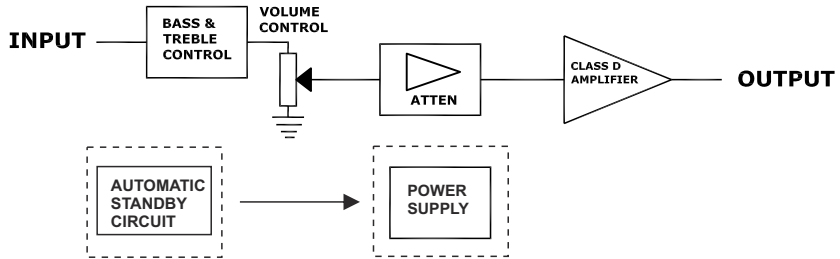

**WARNING:** In order to avoid undesired noise and hum. Be sure **TO CONNECT** the audio input although the audio source will be off

## IP54 weather proof rating

The NEO Series is rated to IP54 which means there is limited dust and water ingress protection.

The NEO Series is designed for both indoor and outdoor operation where it is protected from direct exposure to water (e.g. under a canopy). The use of protection from water and humidity for the connection terminals is highly recommended (e.g. sealant/mastic).

## Plastic Wall-mount bracket

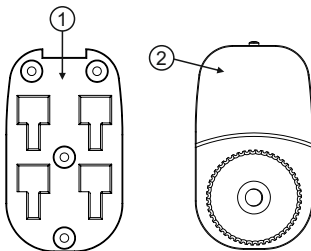

1	Rear wall mounting part
2	Allen Screw 45 mm x M6
3	M6 nut
4	Threaded Ball
5	M10 nut
6	Rear threaded insert (a)
7	Screw eyelet for safety cable (a) (b)

(a) Mounted to loudspeaker

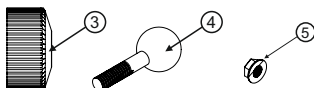

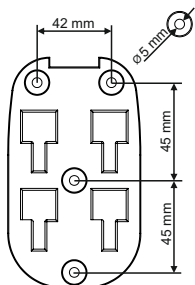

figure 1

## Mounting Process

Use the wall mounting part (1) to mark the fixing points on the wall. Take into account the dimensions between holes and the diameters marked in figure 1. Drill wall and insert wall fixings. Screw wall mounting part to wall. Ensure that suitable screws and wall fixings are used. If in any doubt contact a suitably qualified expert.

Mount (3), (4) & (5) as shown in figure 2. Screw the threaded ball (4) into the threaded insert on the rear of the loudspeaker (6) (loudspeaker not shown below). Tighten M10 nut (5) against the loudspeaker with a spanner. The assembly will now be as shown in figure 3.

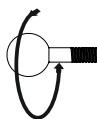

figure 2

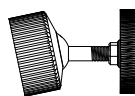

figure 3

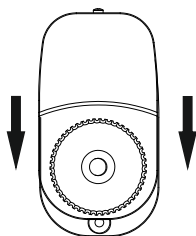
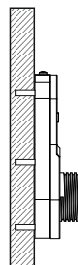
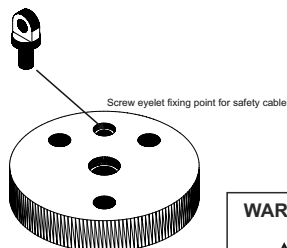
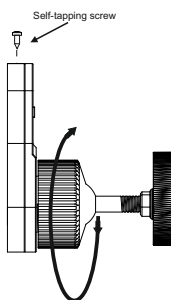

figure 4

Slide the hooks of the front threaded part (2) down in to the slots of the wall mount part (1). (figure 4)



Screw on the rotary knurled ring (3) several turns (do not tighten completely). Now adjust the loudspeaker to the desired position. Hold the speaker in position and tighten the knurled ring (3) completely. Use the self tapping screw (7) provided in order to lock parts (1) & (2) together.



**WARNING:** The maximum loading of this bracket (10 kg), must never be exceeded. No other items must be suspended or attached to the bracket or speaker enclosure.



Un set de NEO 5A ES contiene una caja acústica activa y otra pasiva (color blanco o negro), dos soportes de pared metálicos y un cable link de 3m.

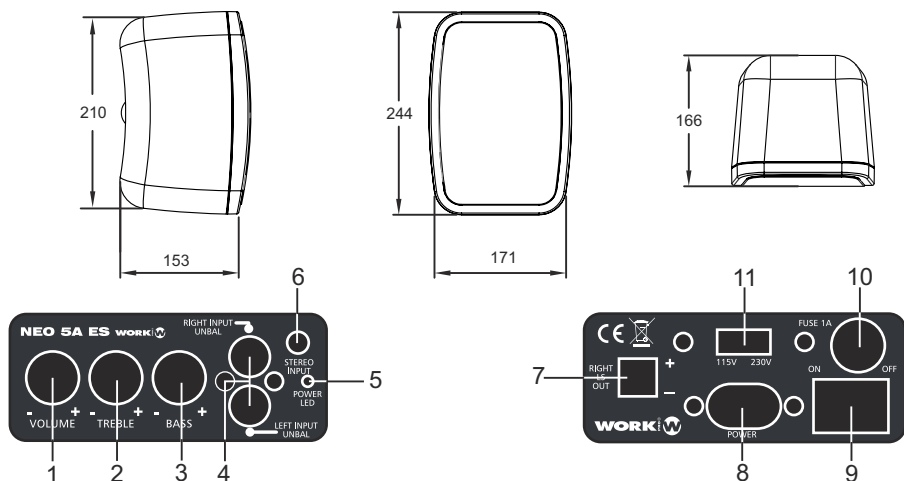

1	Control de Volumen
2	Control Treble
3	Control Bass
4	Entrada desbal. L/R (Conectores RCA)
5	LED power
6	Entrada Estéreo (Mini-jack 3.5 mm) (*)

7	Conect. Link 2-pin euroblock (Unidad pasiva)
8	Alimentación (Use el cable incorporado)
9	Interruptor ON/OFF
10	Portafusible
11	Selector AC 115V/230V

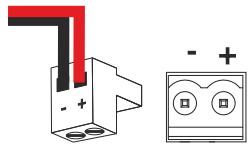

(\*) **Este conector anula la entrada RCA**

El conexasiónado LINK se realiza mediante terminales Euroblock Asegúrese de la correcta polaridad. Use el cable incluido de 2 conductores (Rojo/Negro) de 3 m de longitud para conectar ambos altavoces.

- Elementos..... 5" Woofer + 0,5" Tweeter
- Potencia de Salida ..... 2 x 25 W RMS
- Sensibilidad de entrada..... 1V /2.21 dBu
- Respuesta en frecuencia ..... 60Hz - 20kHz
- Dimensiones ..... 171 x 244 x 166 mm
- Material (recinto) ..... Plástico ABS
- Rnago IP ..... IP 54
- Código color RAL ..... RAL 9003 (W) / RAL 9004 (B)
- Material (rejilla) ..... Aluminio
- Peso ..... 2,7 Kg

Las especificaciones están sujetas a cambio sin previo aviso.

## NEO 5A ES, Bajo consumo en modo “stand-by” (Explicación)

**NEO 5 A ES** incorpora un sistema de bajo consumo de potencia (modo off). De esta forma, en ausencia de señal de entrada durante un periodo de tiempo, el consumo cae por debajo de 1W.

Este sistema se ha diseñado de tal forma que su activación y desactivación se hace inapreciable para la audiencia.

Esta característica cumple con el standard Ecosdesign **EN 62301:2005+1275/2008/EC**

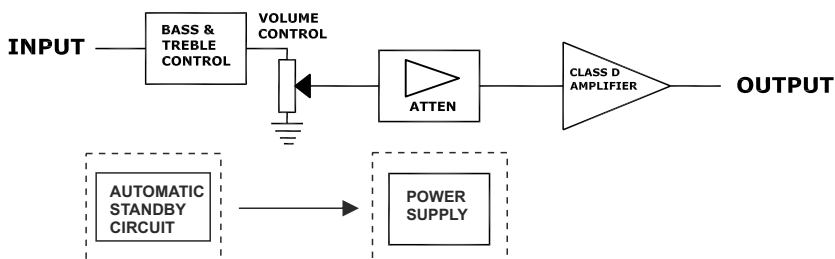

**ADVERTENCIA:** Para evitar ruidos y zumbidos no deseados. Asegúrese de **CONECTAR** la entrada de audio aunque la fuente de audio esté apagada

## Rango de protección IP54

La serie NEO dispone de un rango de protección IP 45, el cual significa que tiene una protección limitada al ingreso de agua y polvo.

La serie NEO está diseñada tanto para instalaciones en interior como exterior donde está protegida de la exposición directa al agua (debajo de un dosel). Es muy recomendable el uso de protecciones contra el agua o la humedad en los terminales de conexión (p.e. sellándolos con silicona o masilla).

## Soporte plástico de pared

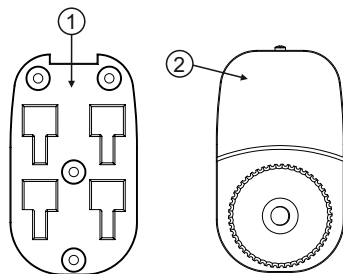

1	Pieza de montaje trasera pared
2	Tornillo Allen 45 mm x M6
3	Tuerca M6
4	Bola roscada
5	Tuerca M10
6	Pieza de inserción trasera (a)
7	Tornillo fijación cable de seguridad (a) (b)

(a) Montado en el altavoz

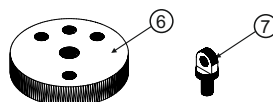
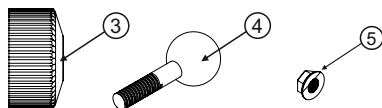



figura 1

### Proceso de Montaje

Use la pieza de montaje (1) para marcar los puntos de fijación a la pared. Tenga en cuenta las medidas y diámetros marcados en la figura 1.  
 Fije la pieza a la pared. Asegúrese de fijarlo con todos los tornillos.  
 Si tiene cualquier duda, consulte con un técnico.

Monte las piezas (3), (4) y (5) como muestra la figura 2. Atornille la pieza (4) dentro de la inserción roscada del altavoz (6). Fije la tuerca M10 (5) contra el altavoz. El montaje se muestra en la figura 3 3.

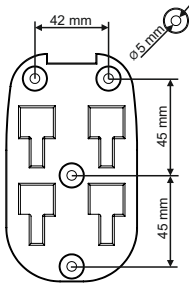

figura 2

figura 3

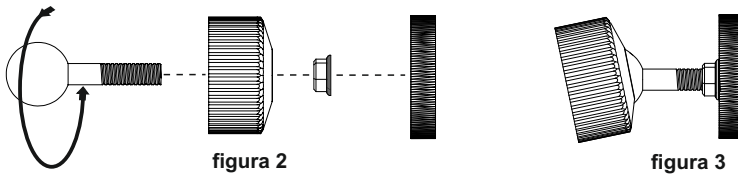

figura 4

Deslice la pieza frontal sobre la pieza montada en la pared (figura 4)



Atornille el aro rotativo (3) varias veces (sin fijarlo totalmente). Ahora ajuste el altavoz en la posición deseada. Fije el altavoz y apriete el aro (3) completamente. Use el tornillo de fijación del cable (7).

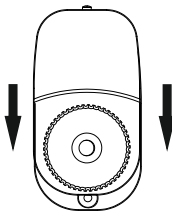
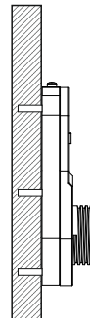
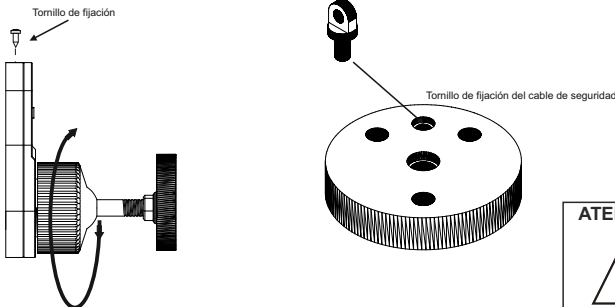

**ATENCIÓN:** La carga máxima de este soporte metálico de pared es de (10 kg), NUNCA debe excederse. Ningún otro elemento debe colgarse de este soporte o de las sujeciones del altavoz



This symbol on the product or on its packaging indicates that this product shall not be treated as household waste. Instead it shall be handed over to the applicable collection point for the recycling of electrical and electronic equipment. By ensuring this product is disposed of correctly, you will help prevent potential negative consequences for the environment and human health, which could otherwise be caused by inappropriate waste handling of this product. The recycling of materials will help to conserve natural resources. For more detailed information about recycling of this product, please contact your local city office, your household waste disposal service or the shop where you purchased the product.

Manufactured by **EQUIPSON, S.A.**

<http://www.equipson.es>