



NEO5 IP



(IP 65)

User Manual / Manual de Uso

A NEO5 IP carton contains two loudspeakers (black or white) and two metallic wall-mount brackets.

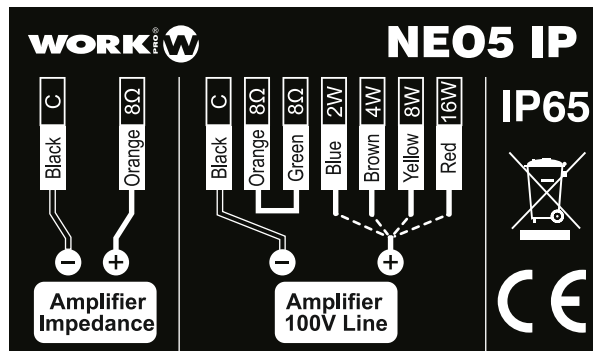
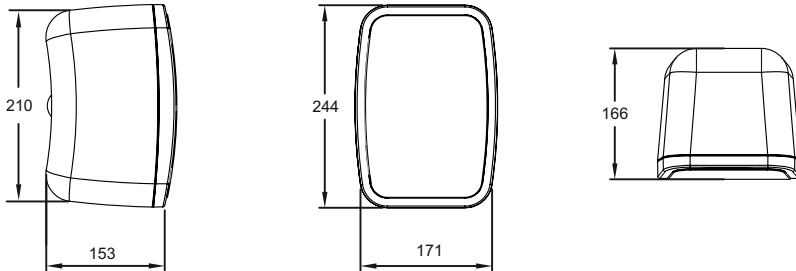

(*) Power Taps (70V).....	1W(4k9Ω)/2W(2k45Ω)/4W(1k22Ω)/8W(612Ω)
Power Taps (100V).....	2W(5kΩ) /4W(2k5Ω) /8W(1k2Ω) /16W(625Ω)
Low Impedance position.....	8Ω(40W)
Sensitivity (1W/1m)	88 dB
Max. SPL	100 dB
Frequency Response	60Hz - 20kHz
Elements.....	5" Woofer + 0,5" Tweeter
Dimensions	171 x 244 x 166 mm
Material (enclosure)	ABS plastic
IP rating	IP 65
RAL colour code	RAL 9003 (W) / RAL 9004 (B)
Material (grille)	Aluminium
Weight	2,3 Kg

(*) The power taps indicated on the selector switch are calculated for 100V line. In the case of 70V line installation, each power tap will correspond to half the value.

Specifications are subject to change without notice

NEO5 IP (IP 65 rating)

This loudspeaker model can be used for outdoor purpose thanks to its high IP range (IP 65). The frontal grille is sealed and the connection is made through a multi-conductor cable sealed with a gland.

NEO5 IP (connection cautions)



Remember, if you need connect the loudspeaker to 70,100V line position, the cables marked as 2 & 3 (Orange, Green), corresponding to 8Ω , MUST BE CONNECTED BETWEEN THEM.



Make sure to select the correct power cable before connecting the loudspeaker to a 70/100V line amplifier. If the low impedance position (8Ω) is selected, the loudspeaker could be damaged!

Plastic Wall-mount bracket

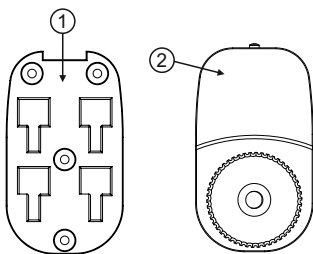

1	Rear wall mounting part
2	Allen Screw 45 mm x M6
3	M6 nut
4	Threaded Ball
5	M10 nut
6	Rear threaded insert (a)
7	Screw eyelet for safety cable (a) (b)

(a) Mounted to loudspeaker

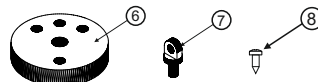
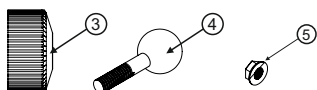

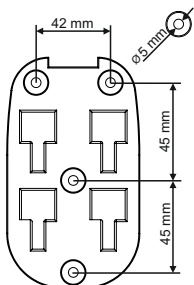

figure 1

Mounting Process

Use the wall mounting part (1) to mark the fixing points on the wall. Take into account the dimensions between holes and the diameters marked in figure 1. Drill wall and insert wall fixings. Screw wall mounting part to wall. Ensure that suitable screws and wall fixings are used. If in any doubt contact a suitably qualified expert.

Mount (3), (4) & (5) as shown in figure 2. Screw the threaded ball (4) into the threaded insert on the rear of the loudspeaker (6) (loudspeaker not shown below). Tighten M10 nut (5) against the loudspeaker with a spanner. The assembly will now be as shown in figure 3.

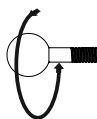

figure 2

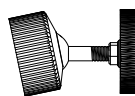

figure 3

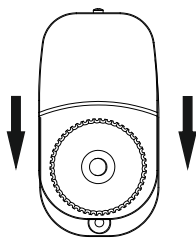
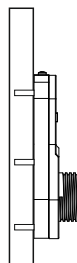
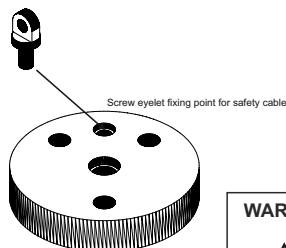
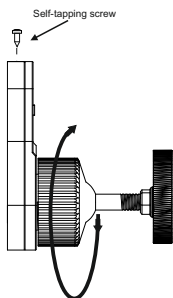

figure 4

Slide the hooks of the front threaded part (2) down in to the slots of the wall mount part (1). (figure 4)



Screw on the rotary knurled ring (3) several turns (do not tighten completely). Now adjust the loudspeaker to the desired position. Hold the speaker in position and tighten the knurled ring (3) completely. Use the self tapping screw (7) provided in order to lock parts (1) & (2) together.



WARNING: The maximum loading of this bracket (10 kg), must never be exceeded. No other items must be suspended or attached to the bracket or speaker enclosure.

NEO5 IP WORK®

ES

Un set de NEO5 IP contiene dos altavoces (color blanco o negro) y 2 soportes de pared metálicos.

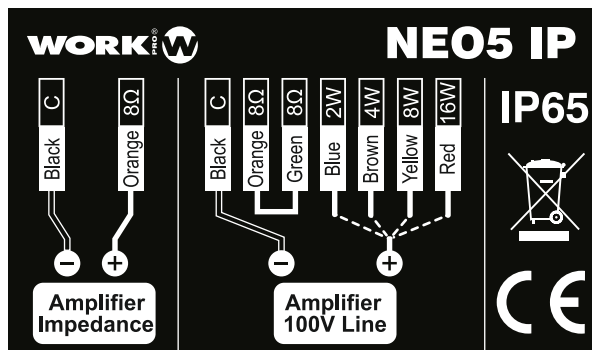
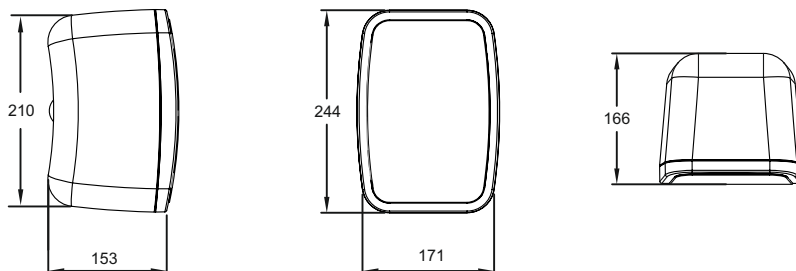

(*) Potencia (70V).....	1W(4k9Ω)/2W(2k45Ω)/4W(1k22Ω)/8W(612Ω)
Potencia (100V).....	2W(5kΩ) /4W(2k5Ω) /8W(1k2Ω) /16W(625Ω)
Potencia a baja impedancia.....	8Ω(40W)
Sensibilidad (1W/1m)	88 dB
Max. SPL	100 dB
Respuesta en frecuencia	60Hz - 20kHz
Elementos.....	5" Woofer + 0,5" Tweeter
Dimensiones	171 x 244 x 166 mm
Material (recinto)	ABS plastic
Rango IP	IP 65
Código color RAL	RAL 9003 (W) / RAL 9004 (B)
Material (rejilla)	Aluminio
Peso.....	2,3 Kg

(*) Las posiciones indicadas en el selector están calculadas para línea de 100V. En el caso de una instalación de línea 70V, cada posición de potencia corresponderá a la mitad del valor.

Las especificaciones están sujetas a cambio sin previo aviso.

NEO5 IP (rango IP 65)

Este modelo de caja acústica puede ser utilizado en aplicados de exterior gracias a su alto rango IP (IP 65). La rejilla frontal está sellada y el conexionado se realiza mediante un cable multi-conector sellado con un prensaestopa.

NEO5 IP (precauciones de conexionado)



Recuerde que para conectar el altavoz a una posición de línea 70/100V, los cables marcados como 2 y 3 (Naranja y Verde) correspondientes a 8Ω , deben CONECTARSE ENTRE SI



Asegúrese de seleccionar el cable correcto de potencia antes de conectar el altavoz a un amplificador de línea 70/100V. Si se selecciona el cable de baja impedancia (8Ω), el altavoz puede dañarse.

Soporte plástico de pared

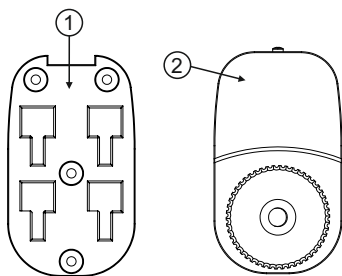

1	Pieza de montaje trasera pared
2	Tornillo Allen 45 mm x M6
3	Tuerca M6
4	Bola roscada
5	Tuerca M10
6	Pieza de inserción trasera (a)
7	Tornillo fijación cable de seguridad (a) (b)

(a) Montado en el altavoz

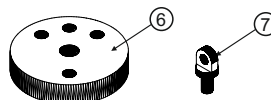
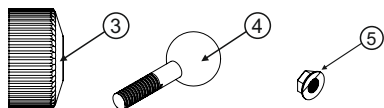



figura 1

Proceso de Montaje

Use la pieza de montaje (1) para marcar los puntos de fijación a la pared. Tenga en cuenta las medidas y diámetros marcados en la figura 1.
 Fije la pieza a la pared. Asegúrese de fijarlo con todos los tornillos.
 Si tiene cualquier duda, consulte con un técnico.

Monte las piezas (3), (4) y (5) como muestra la figura 2. Atornille la pieza (4) dentro de la inserción roscada del altavoz (6). Fije la tuerca M10 (5) contra el altavoz. El montaje se muestra en la figura 3.

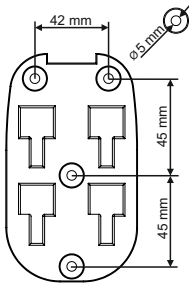

figura 2



figura 3

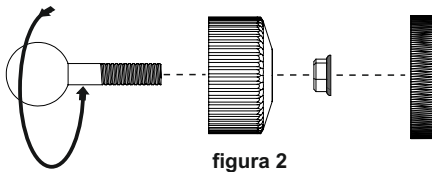

figura 4

Deslice la pieza frontal sobre la pieza montada en la pared (figura 4)

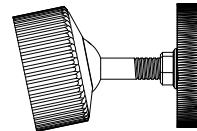
Atornille el aro rotativo (3) varias veces (sin fijarlo totalmente). Ahora ajuste el altavoz en la posición deseada. Fije el altavoz y apriete el aro (3) completamente. Use el tornillo de fijación del cable (7).

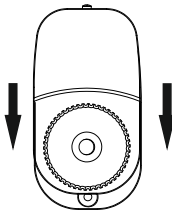
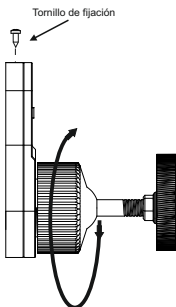
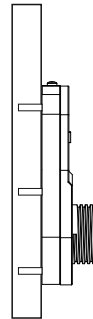

Tornillo de fijación

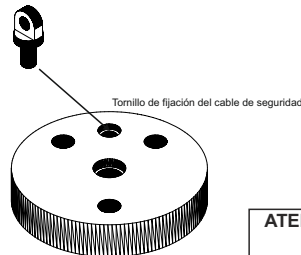

Tornillo de fijación del cable de seguridad

ATENCIÓN: La carga máxima de este soporte metálico de pared es de (10 kg), NUNCA debe excederse. Ningún otro elemento debe colgarse de este soporte o de las sujeciones del altavoz



This symbol on the product or on its packaging indicates that this product shall not be treated as household waste. Instead it shall be handed over to the applicable collection point for the recycling of electrical and electronic equipment. By ensuring this product is disposed of correctly, you will help prevent potential negative consequences for the environment and human health, which could otherwise be caused by inappropriate waste handling of this product. The recycling of materials will help to conserve natural resources. For more detailed information about recycling of this product, please contact your local city office, your household waste disposal service or the shop where you purchased the product.

Manufactured by **EQUIPSON, S.A.**

<http://www.equipson.es>